



FAN400C — Low-Power, Green-Mode, PWM Flyback Power Controller without Secondary Feedback (CC)

Features

- Linearly Decreasing PWM Frequency
- Green Mode Under Light-Load and Zero-Load Conditions
- Constant Current (CC) without Secondary-Feedback Circuitry
- Low Startup Current: 8µA
- Low Operating Current: 3.6mA
- Leading-Edge Blanking
- Constant Power Limit
- Universal AC Input Range
- Synchronized Slope Compensation
- 140°C OTP Sensor with Hysteresis
- V_{DD} Over-Voltage Protection (Auto Restart)
- Cycle-by-Cycle Current Limiting
- Under-Voltage Lockout (UVLO)
- Fixed PWM Frequency with Hopping
- Gate Output Maximum Voltage Clamped at 17V
- Small SSOT-6 Package

Applications

General-purpose, switching-mode power supplies and flyback power converters, such as:

- Battery Chargers for Cellular Phones, Cordless Phones, PDAs, Digital Cameras, Power Tools
- Power Adapters for Ink Jet Printers, Video Game Consoles, Portable Audio Players
- Open-Frame SMPS for TV/DVD Standby and Auxiliary Supplies, Home Appliances, Consumer Electronics
- Replacement for Linear Transformers and RCC SMPS
- PC 5V Standby Power

Description

This highly integrated PWM controller provides several features to enhance the performance of low-power flyback converters. To minimize standby power consumption, a proprietary green-mode function provides off-time modulation to linearly decrease the switching frequency under light-load and zero-load conditions. This green mode enables the power supply to meet international power conservation requirements. Another advantage of the FAN400C is that the typical startup current is only 8µA, while the typical operating current can be as low as 3.6mA. A large startup resistance can be used to achieve higher power conversion efficiency.

FAN400C integrates a frequency-hopping function internally to reduce EMI emissions with minimum line filters. Built-in synchronized slope compensation maintains the stability of peak current-mode control. Proprietary internal compensation ensures constant output power limiting over a universal range of AC input voltages, from 90V_{AC} to 264V_{AC}.

The FAN400C provides many protection functions. Pulse-by-pulse current limiting ensures constant output current, even if a short circuit occurs. The internal protection circuit disables PWM output if V_{DD} exceeds 24.5V. The gate output is clamped at 17V to protect the power MOS from over-voltage damage. The built-in over-temperature protection (OTP) function shuts down the controller at 140°C with a 30°C hysteresis.

The FAN400C is designed to provide a low-cost total solution for flyback converters. It is available in a small footprint, 6-pin, SSOT-6 and 8-pin DIP packages.

Related Resources

- *AN-6072 — Low-Power, Green-Mode, PWM Flyback Power Controller without Secondary Feedback*

Ordering Information

Part Number	Operating Temperature Range	Package	 Eco Status	Packing Method
FAN400CTY	-40°C to +105°C	SSOT-6	Green	Tape & Reel
FAN400CNY	-40°C to +105°C	DIP-8	Green	Tube

 For Fairchild's definition of "green" please visit: http://www.fairchildsemi.com/company/green/rohs_green.html.

Application Diagram

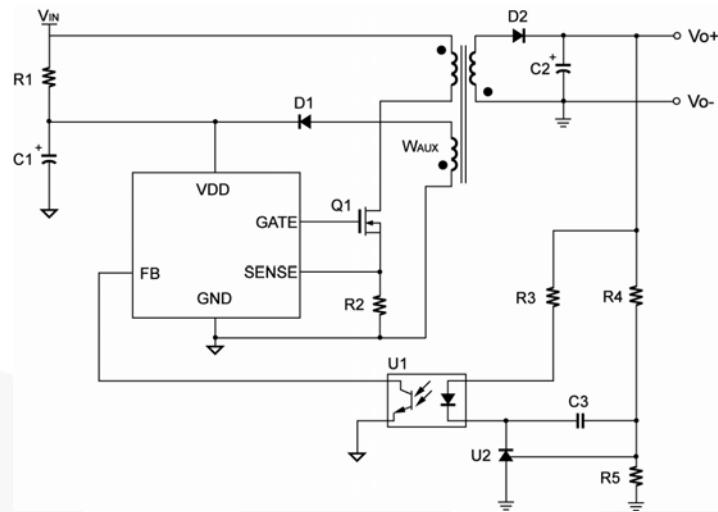

Figure 1. Typical Application

Internal Block Diagram

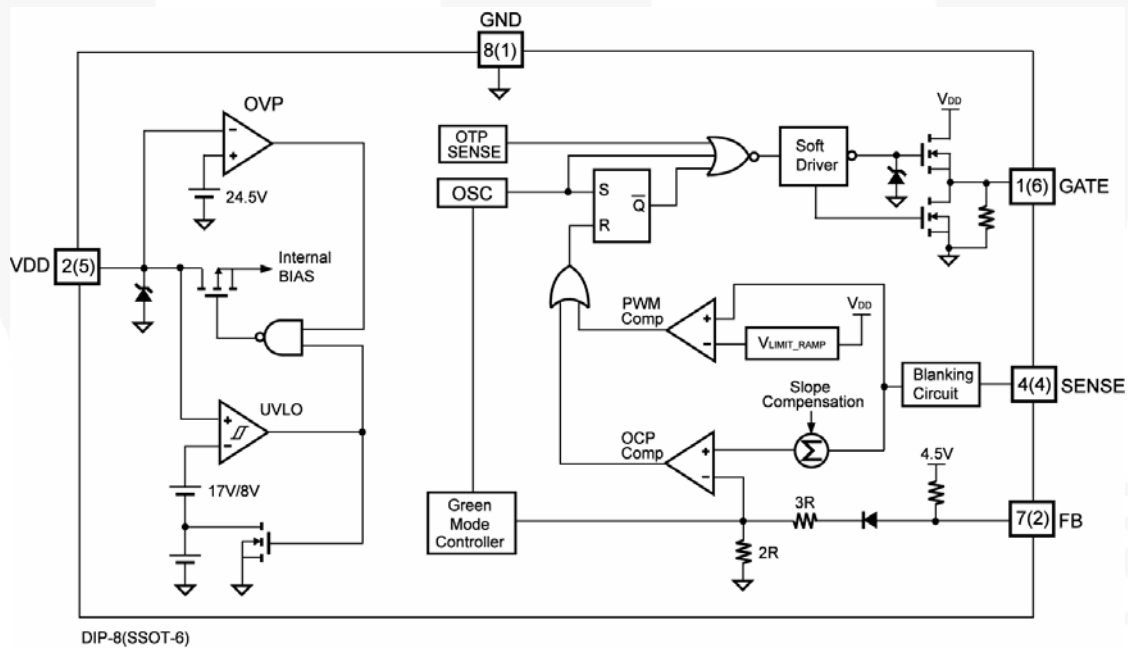
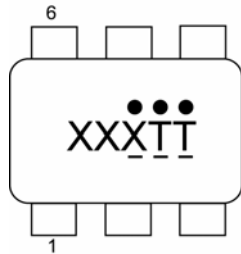
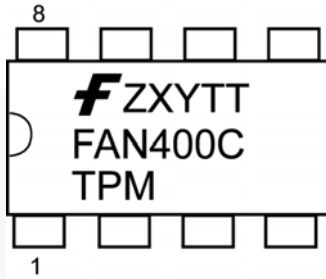

Figure 2. Functional Block Diagram

Marking Information



XXX: AAU=FAN400C
TT : Die run code
. . . : Year code
- - - : Week code



1'st line
Z: Assembly plant code
X: Year code
Y: Week code
TT: Die run code
3'rd line
T: N=DIP
P: Z=Lead free + RoHS compatible
Y=Green package
M: Manufacture flow code

Figure 3. Top Mark

Pin Configurations

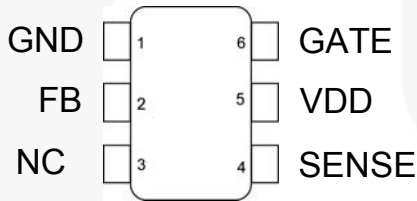

Figure 4. SSOT-6 Pin Configuration

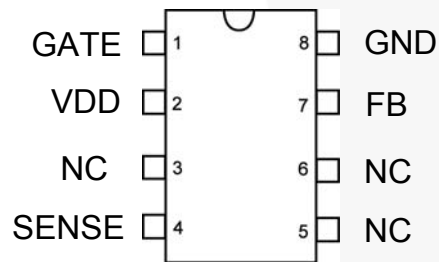

Figure 5. DIP-8 Pin Configuration

Pin Definitions

DIP Pin #	SSOT Pin #	Name	Description
1	6	GATE	The totem-pole output driver to drive the power MOSFET
2	5	VDD	Power supply
3		NC	No connection
4	4	SENSE	Current-sense detects the voltage across a sensed resistor. To provide over-current protection, PWM output is disabled if the voltage exceeds an internal threshold. This pin also provides current information for current-mode control.
5		NC	No connection
6	3	NC	No connection
7	2	FB	The FB pin provides feedback information to the internal PWM comparator. This feedback is used to control the duty cycle.
8	1	GND	Ground

Absolute Maximum Ratings

Stresses exceeding the absolute maximum ratings may damage the device. The device may not function or be operable above the recommended operating conditions and stressing the parts to these levels is not recommended. In addition, extended exposure to stresses above the recommended operating conditions may affect device reliability. The absolute maximum ratings are stress ratings only.

Symbol	Parameter	Min.	Max.	Unit
V _{DD}	DC Supply Voltage ^(1,2)		30	V
V _{FB}	Input Voltage to FB Pin	-0.3	7.0	V
V _{SENSE}	Input Voltage to Sense Pin	-0.3	7.0	V
T _J	Operating Junction Temperature		+150	°C
Θ _{JA}	Thermal Resistance (Junction-to-Air)	SOT	263.3	°C/W
		DIP	135.7	°C/W
T _{STG}	Storage Temperature Range	-55	+150	°C
T _L	Lead Temperature (Wave Soldering or IR, 10 Seconds)		+260	°C
ESD	Electrostatic Discharge Capability	Human Body Model JEDEC: JESD22-A114	4	kV
		Machine Model, JEDEC: JESD22-A115	200	V

Notes:

1. All voltage values, except differential voltages, are given with respect to GND pin.
2. Stresses beyond those listed under "absolute maximum ratings" may cause permanent damage to the device.

Electrical Characteristics

Unless otherwise noted, $V_{DD}=15V$ and $T_A=25^\circ C$.

Symbol	Parameter	Conditions	Min.	Typ.	Max.	Units
V_{DD} Section						
V_{DD-OP}	Continuously Operation Voltage				23.5	V
V_{DD-ON}	Turn-On Threshold Voltage		16	17	18	V
V_{DD-OFF}	Turn-Off Threshold Voltage		7.5	8.0	8.5	V
I_{DD-ST}	Startup Current	$V_{DD}=V_{DD-ON} - 0.1V$		8	20	μA
I_{DD-OP}	Operating Supply Current	$C_L=1nF$		3.6	4.6	mA
$V_{DD-G OFF}$	V_{DD} Low-threshold Voltage to Exit Green-off Mode			$V_{DD-OFF}+1.2$		V
V_{DD-OVP}	V_{DD} Over-Voltage Protection		23.5	24.5	25.5	V
$t_{D-VDDOVP}$	V_{DD} Over-Voltage Protection Debounce Time		70	135	200	μs
Feedback Input Section						
A_V	Input-Voltage to Current-Sense Attenuation			0.3		V/V
Z_{FB}	Input Impedance	$I_{FB}=0.1mA$ to $0.2mA$		4.6		k Ω
$V_{FB-OPEN}$	Open-Loop Voltage		4.5			V
Current-Sense Section						
t_{PD}	Propagation Delay			100	150	ns
V_{STHVA}	Current Limit Valley Threshold Voltage	$V_{DD}=18V$		0.81		V
		$V_{DD}=15V$		0.73		V
		$V_{DD}=10V$		0.58		V
V_{STHFL}	Current Limit Flat Threshold Voltage	$V_{DD}=18V$		1.10		V
		$V_{DD}=15V$		1.01		V
		$V_{DD}=10V$		0.81		V
t_{LEB}	Leading-Edge Blanking Time		250	310	370	ns

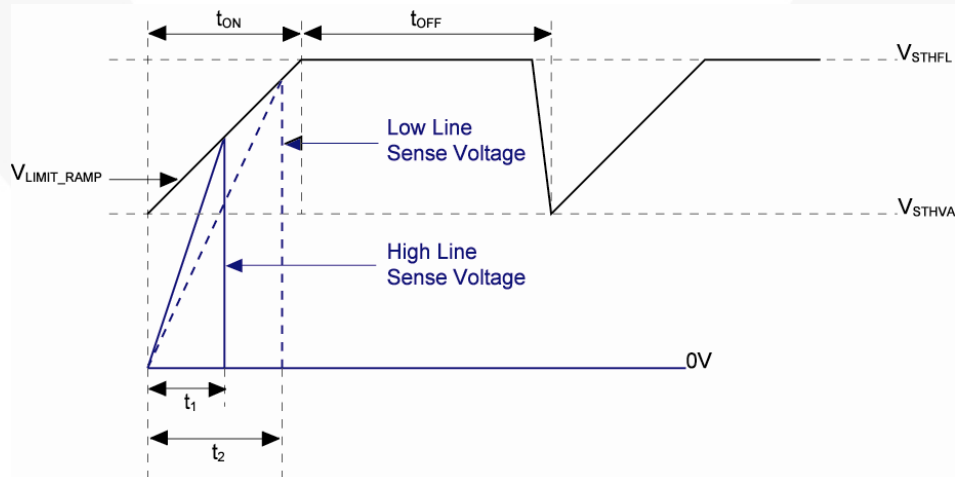

Figure 6. Saw Limit

Electrical Characteristics (Continued)Unless otherwise noted, $V_{DD}=15V$ and $T_A=25^{\circ}C$.

Symbol	Parameter	Conditions	Min.	Typ.	Max.	Units	
Oscillator Section							
f_{OSC}	Frequency	Center Frequency		60	65	70	kHz
		Hopping Range		± 4.0	± 4.6	± 5.2	
t_{HOP}	Hopping Period			4		ms	
f_{OSC-G}	Green Mode Frequency			14.5	17.0	19.5	KHz
V_{FB-N}	Green Mode Entry FB Voltage			2.3	2.6	2.9	V
V_{FB-G}	Green Mode Ending FB Voltage				$V_{FB-N} - 0.75$		V
V_{FB-Z}	Zero Duty Cycle FB Voltage				1.45		V
S_G	Green Mode Modulation Slope			40	70	100	Hz/mV
f_{DV}	Frequency Variation vs. V_{DD} Deviation		$V_{DD}=10$ to $22V$			2	%
f_{DT}	Frequency Variation vs. Temperature Deviation		$T_A=-20$ to $85^{\circ}C$		1.5	5.0	%
Output Section							
DCY_{MAX}	Maximum Duty Cycle			68	73	78	%
V_{GATE-L}	GATE Low Voltage		$I_O=10mA$			1.5	V
V_{GATE-H}	GATE High Voltage		$I_O=-10mA$	8			V
t_r	GATE Rising Time		$C_L=1nF$	150	200	250	ns
t_f	GATE Falling Time		$C_L=1nF$	70	90	110	ns
$V_{GATE-CLAMP}$	GATE Output Clamping Voltage		$V_{DD}=20V$	16	17	18	V
Over-Temperature Protection (OTP)							
T_{OTP}	Protection Junction Temperature				+140		$^{\circ}C$
$T_{OTP-RESTART}$	Restart Junction Temperature				+110		$^{\circ}C$

Typical Performance Characteristics

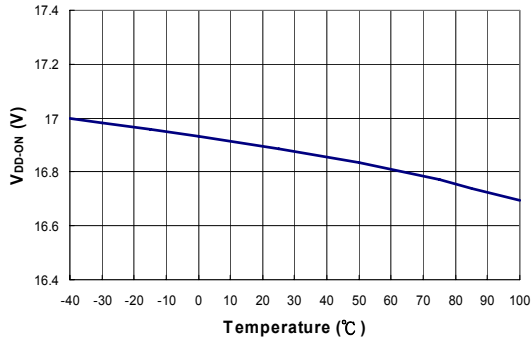

Figure 7. Turn-on Threshold Voltage (V_{DD-ON}) vs. Temperature

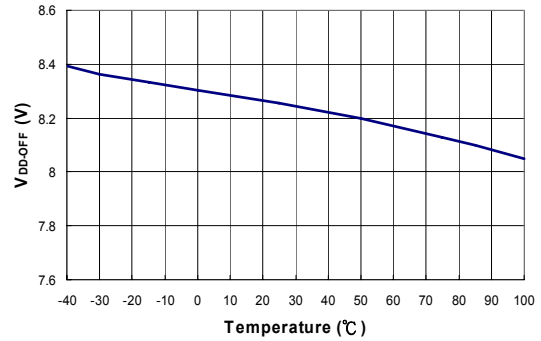

Figure 8. Turn-off Threshold Voltage (V_{DD-OFF}) vs. Temperature

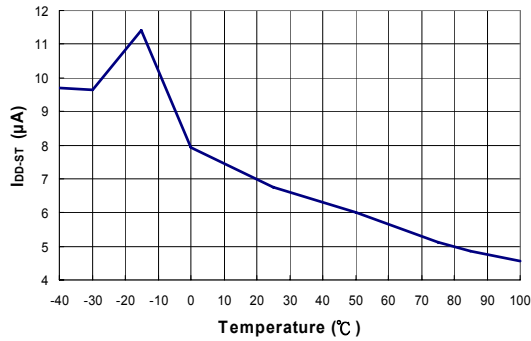

Figure 9. Startup Current (I_{DD-ST}) vs. Temperature

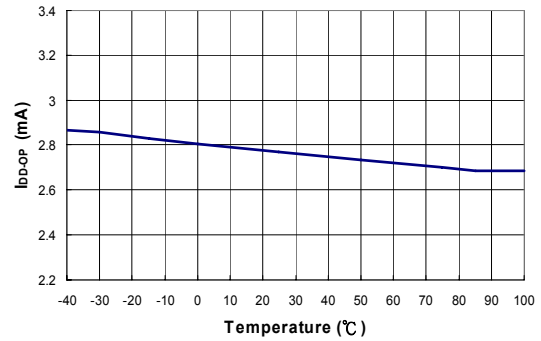

Figure 10. Operating Supply Current (I_{DD-OP}) vs. Temperature

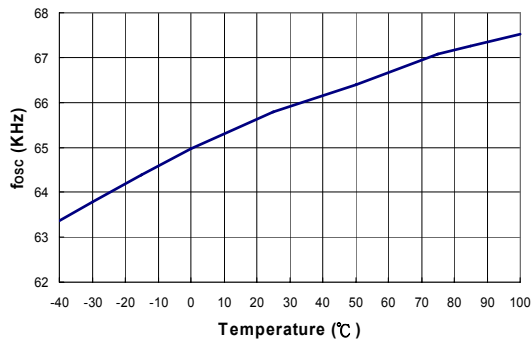

Figure 11. Center Frequency (f_{OSC}) vs. Temperature

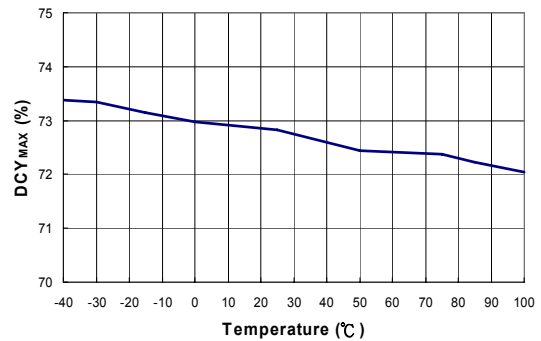

Figure 12. Maximum Duty Cycle (DCY_{MAX}) vs. Temperature

Typical Performance Characteristics

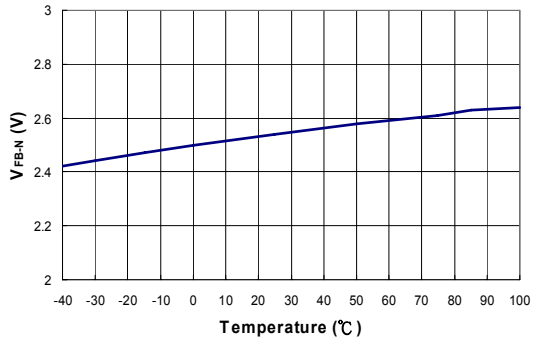

Figure 13. Green Mode Entry FB Voltage (V_{FB-N}) vs. Temperature

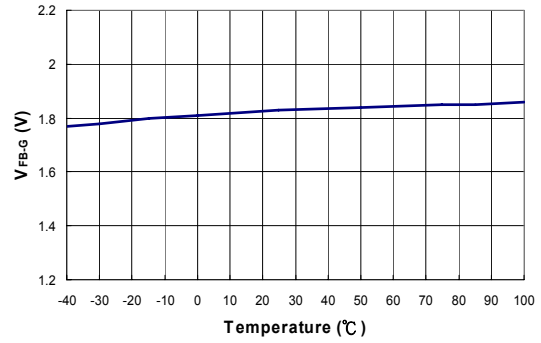

Figure 14. Green Mode Ending FB Voltage (V_{FB-G}) vs. Temperature

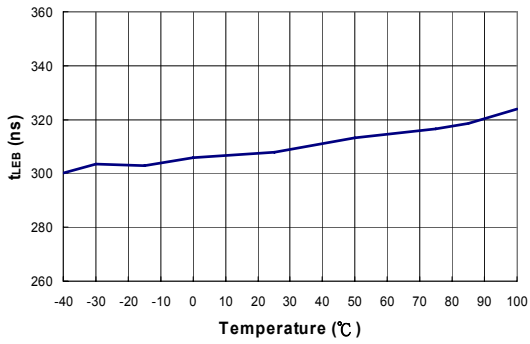

Figure 15. Leading-Edge Blanking Time (t_{LEB}) vs. Temperature

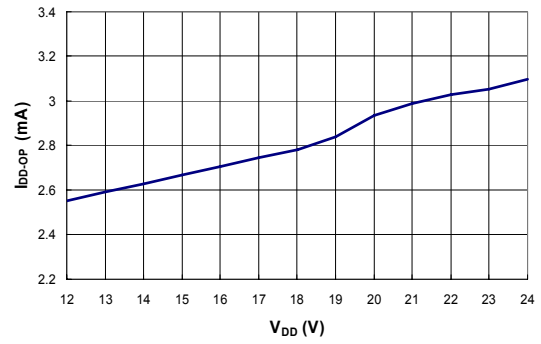

Figure 16. Operating Supply Current vs. V_{DD} Voltage

Operation Description

FAN400C devices integrate many useful functions for low-power switch-mode power supplies. The following descriptions highlight the key features of the FAN400C.

Startup Current

The required startup current is only 8mA, which allows a high-resistance, low-wattage startup resistor to supply the controller's startup power. A 1.5M Ω /0.25W startup resistor can be used over a wide input range (100V-240V_{AC}) with very little power loss.

Operating Current

The operating current is normally 3.6mA, which results in higher efficiency and reduces the required V_{DD} hold-up capacitance. A 10 μ F/25V V_{DD} hold-up capacitor can be used over a wide input range (100V-240V_{AC}) with very little power loss.

Green-Mode Operation

The proprietary green-mode function provides off-time modulation to linearly decrease the switching frequency under light-load and zero-load conditions. The on-time is limited to provide better protection against brownouts and other abnormal conditions. Power supplies using the FAN400C can meet international restrictions regarding standby power-consumption.

Current (CC) without Feedback

The FAN400C can provide over-current protection without requiring secondary-side feedback signals. For improved CV and CC accuracy, the transformer leakage inductance should be reduced as much as possible.

Over-Temperature Protection (OTP)

The FAN400C has a built-in temperature-sensing circuit to shut down PWM output once the junction temperature exceeds 140°C. While PWM output is shut down, the V_{DD} voltage gradually drops to the UVLO voltage. Some of the internal circuits are shut down and V_{DD} gradually starts increasing again. When V_{DD} reaches 17V, all the internal circuits, including the temperature-sensing circuit, operate normally. If the junction temperature is still higher than 140°C, the PWM controller shuts down immediately. This situation continues until the temperature drops below 110°C. The PWM output is then turned back on. The temperature hysteresis window for the OTP circuit is 30°C.

V_{DD} Over-Voltage Clamping

V_{DD} over-voltage clamping prevents damage from over-voltage conditions. When V_{DD} exceeds 24.5V, PWM output is shut down. Over-voltage conditions may be caused by an open photo-coupler loop or a short circuit in the output.

Oscillator Operation

The oscillation frequency is fixed at 65KHz.

Leading-Edge Blanking (LEB)

Each time the power MOSFET is switched on, a turn-on spike occurs at the sense-resistor. To avoid premature termination of the switching pulse, a 310ns leading-edge blanking time is built in. Conventional RC filtering is not necessary. During this blanking period, the current-limit comparator is disabled and cannot switch off the gate drive.

Constant Output Power Limit

When the SENSE voltage across the sense resistor R_S reaches the threshold voltage (around 1.0V), the output GATE drive is turned off following a small propagation delay, t_{PD}. This propagation delay introduces an additional current proportional to t_{PD}•V_{IN}/L_P. The propagation delay is nearly constant regardless of the input line voltage V_{IN}. Higher input line voltages result in larger additional currents. Under high input-line voltages, the output power limit is higher than under low input-line voltages. Over a wide range of AC input voltages, the variation can be significant. To compensate for this, the threshold voltage is adjusted by adding a positive ramp (V_{limit_ramp}). This ramp signal can vary from 0.73V to 1.01V and flattens out at 1.01V. A smaller threshold voltage forces the output GATE drive to terminate earlier, reducing total PWM turn-on time and making the output power equal to that of the low-line input. This proprietary internal compensation feature ensures a constant output power limit over a wide range of AC input voltages (90V_{AC} to 264V_{AC}).

Under-Voltage Lockout (UVLO)

The turn-on/turn-off thresholds are fixed internally at 17V and 8V. To enable the FAN400C during startup, the hold-up capacitor must first be charged to 17V through the startup resistor. The hold-up capacitor continues to supply V_{DD} before energy can be delivered from the auxiliary winding of the main transformer. V_{DD} must not drop below 8V during this startup process. This UVLO hysteresis window ensures that the hold-up capacitor can adequately supply V_{DD} during startup.

Gate Output

The BiCMOS output stage is a fast totem-pole gate driver. Cross-conduction is avoided to minimize heat dissipation, increase efficiency, and enhance reliability. The output driver is clamped by an internal 17V Zener diode to protect the power MOSFET transistors against any harmful over-voltage gate signals.

Operation Description (Continued)

Slope Compensation

The sensed voltage across the current-sense resistor is used for current-mode control and pulse-by-pulse current limiting. The built-in slope compensation improves power supply stability. Furthermore, it prevents sub-harmonic oscillations that normally would occur because of peak-current mode control. A positively sloped, synchronized ramp is activated with every switching cycle. The slope of the ramp is:

$$\frac{0.33 \times \text{Duty}}{\text{Duty (max.)}} \quad (1)$$

Noise Immunity

Noise from the current-sense or the control signal may cause significant pulse-width jitter, particularly in continuous-conduction mode. Slope compensation helps alleviate this problem. Good placement and layout practices should be followed. Avoid long PCB traces and component leads. Compensation and filter components should be located near the FAN400C. Increasing the power-MOS gate resistance is advised.

Applications Information

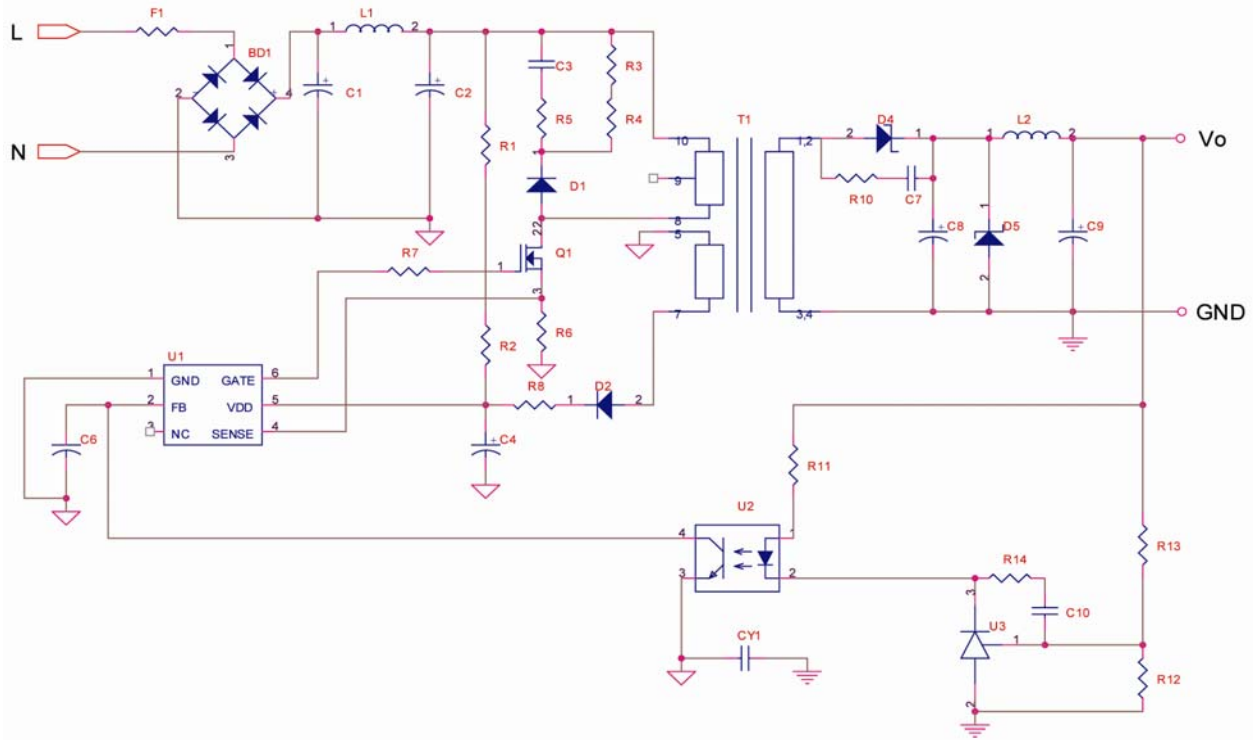
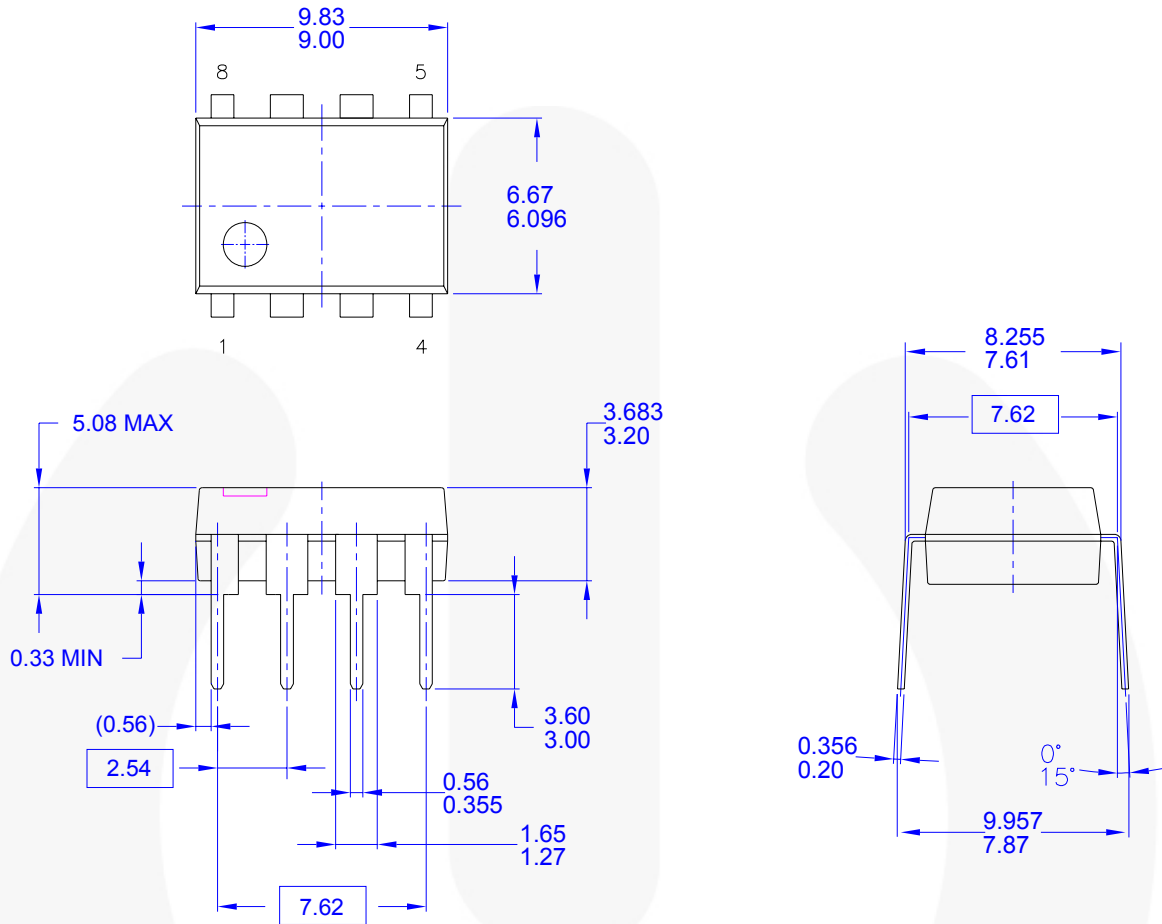

Figure 17. Reference Circuit

BOM

Reference	Component	Reference	Component
BD1	BD DI106 1A/600V	L2	Inductor 10 μ H 6mm
CY1 (Option)	YC 2.2nF/250V (Y1)	Q1	MOSFET 1A/600V
C1	EC 4.7 μ F/400V 105 $^{\circ}$ C	R1,R2	R 750 Ω /1206
C2	EC 4.7 μ F/400V 105 $^{\circ}$ C	R3,R4	R 47k Ω /1206
C3	CC 1nF/1kV	R5	R 47 Ω /1206
C4	EC 10 μ F/50V	R6	R 4.7 Ω /0.5W
C6	CC 4.7nF/0805	R7	R 100 Ω /0805
C7 (Option)	CC 1nF/100V 1206	R8	R 10 Ω /1206
C8	EC 470 μ F/10V 105 $^{\circ}$ C	R10	R 10 Ω /1206
C9	EC 470 μ F/10V 105 $^{\circ}$ C	R11	R 100 Ω / 1/8W
C10	CC 2.2nF/0805	R12	R 33k Ω /0805
D1	Diode FRI07	R13	R 33k Ω / 1/8W
D2	Diode FR102	R14	R 4.7k Ω /0805
D4	Diode SB360	T1	Transformer EE-16
D5 (Option)	ZD 6.8V/0.5W	U1	IC FAN400C (Green PWM IC)
F1	R 1 Ω /0.5W	U2	IC PC817
L1	Inductor 20mH 6*8mm	U3	IC TL431

Physical Dimensions



- NOTES: UNLESS OTHERWISE SPECIFIED
- A) THIS PACKAGE CONFORMS TO JEDEC MS-001 VARIATION BA
 - B) ALL DIMENSIONS ARE IN MILLIMETERS.
 - C) DIMENSIONS ARE EXCLUSIVE OF BURRS, MOLD FLASH, AND TIE BAR EXTRUSIONS.
 - D) DIMENSIONS AND TOLERANCES PER ASME Y14.5M-1994
 - E) DRAWING FILENAME AND REVISION: MKT-N08FREV2.

Figure 18. 8-Pin, DIP-8 Package

Package drawings are provided as a service to customers considering Fairchild components. Drawings may change in any manner without notice. Please note the revision and/or date on the drawing and contact a Fairchild Semiconductor representative to verify or obtain the most recent revision. Package specifications do not expand the terms of Fairchild's worldwide terms and conditions, specifically the warranty therein, which covers Fairchild products.

Always visit Fairchild Semiconductor's online packaging area for the most recent package drawings:
<http://www.fairchildsemi.com/packaging/>.

Physical Dimensions (Continued)

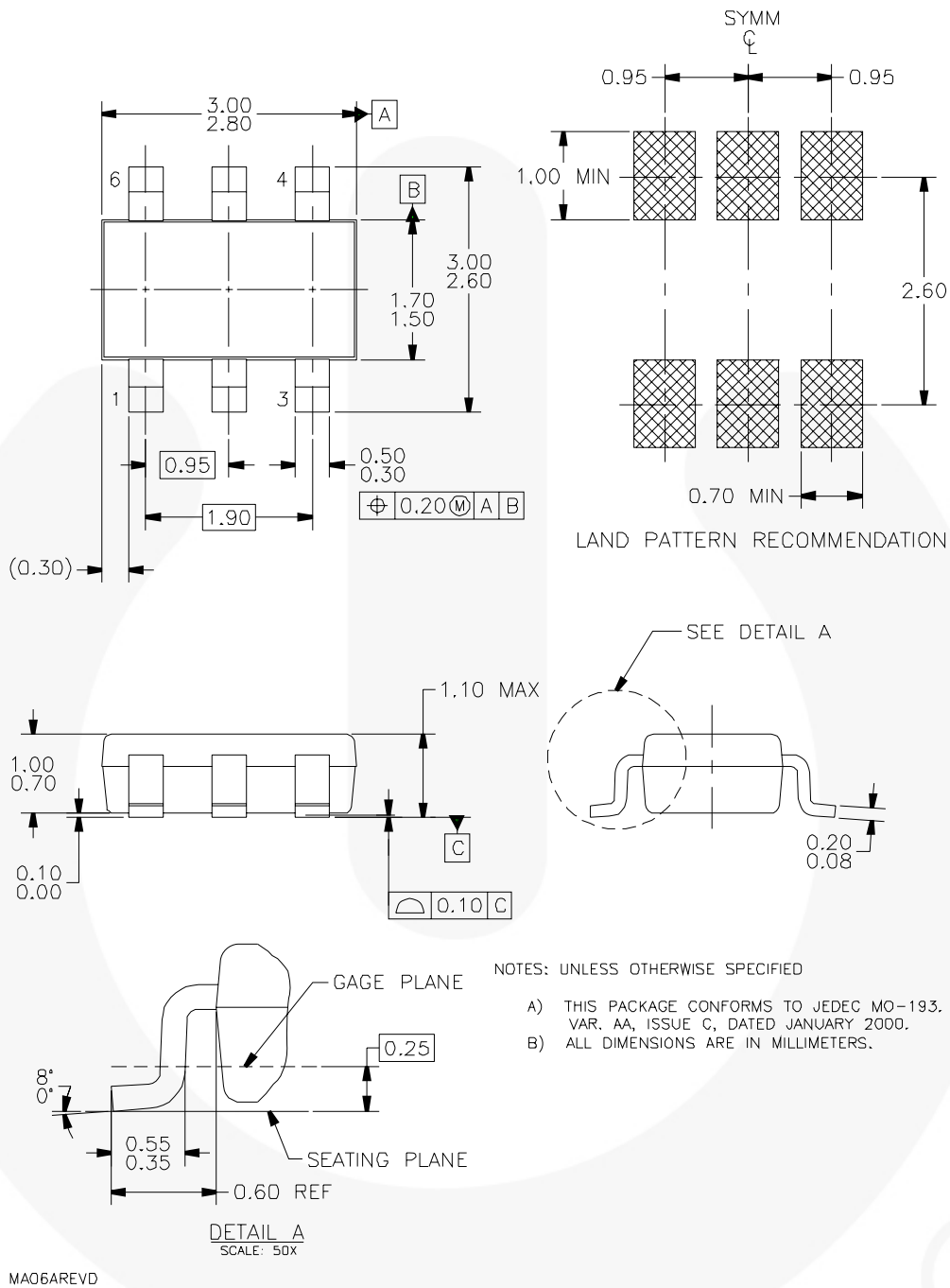

Figure 19. 6-Pin SSOT-6 Package







Package drawings are provided as a service to customers considering Fairchild components. Drawings may change in any manner without notice. Please note the revision and/or date on the drawing and contact a Fairchild Semiconductor representative to verify or obtain the most recent revision. Package specifications do not expand the terms of Fairchild's worldwide terms and conditions, specifically the warranty therein, which covers Fairchild products.

Always visit Fairchild Semiconductor's online packaging area for the most recent package drawings:
<http://www.fairchildsemi.com/packaging/>.



TRADEMARKS

The following includes registered and unregistered trademarks and service marks, owned by Fairchild Semiconductor and/or its global subsidiaries, and is not intended to be an exhaustive list of all such trademarks.

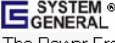
- | | | | |
|--|---|--|---|
| Build it Now™ | FRFET® | Programmable Active Droop™ | 
TinyBoost™
TinyBuck™
TinyLogic®
TINYOPTO™
TinyPower™
TinyPWM™
TinyWire™
µSerDes™

UHC®
Ultra FRFET™
UniFET™
VCX™
VisualMax™
XS™ |
| CorePLUS™ | Global Power Resource SM | QFET® | |
| CorePOWER™ | Green FPST™ | QST™ | |
| CROSSVOLT™ | Green FPST™ e-Series™ | Quiet Series™ | |
| CTL™ | GTO™ | RapidConfigure™ | |
| Current Transfer Logic™ | IntelliMAX™ | 
Saving our world, 1mW/W/kW at a time™ | |
| EcoSPARK® | ISOPLANAR™ | SmartMax™ | |
| EfficientMax™ | MegaBuck™ | SMART START™ | |
| EZSWITCH™ * | MICROCOUPLER™ | SPM® | |
| 

Fairchild®
Fairchild Semiconductor®
FACT Quiet Series™
FACT®
FAST®
FastvCore™
FlashWriter®*
FPS™
F-PFST™ | MicroFET™
MicroPak™
MillerDrive™
MotionMax™
Motion-SPM™
OPTOLOGIC®
OPTOPLANAR®

PDP SPM™
Power-SPM™
PowerTrench®
PowerXS™ | STEALTH™
SuperFET™
SuperSOT™.3
SuperSOT™.6
SuperSOT™.8
SupreMOS™
SyncFET™

The Power Franchise® | |

* EZSWITCH™ and FlashWriter® are trademarks of System General Corporation, used under license by Fairchild Semiconductor.

DISCLAIMER

FAIRCHILD SEMICONDUCTOR RESERVES THE RIGHT TO MAKE CHANGES WITHOUT FURTHER NOTICE TO ANY PRODUCTS HEREIN TO IMPROVE RELIABILITY, FUNCTION, OR DESIGN. FAIRCHILD DOES NOT ASSUME ANY LIABILITY ARISING OUT OF THE APPLICATION OR USE OF ANY PRODUCT OR CIRCUIT DESCRIBED HEREIN; NEITHER DOES IT CONVEY ANY LICENSE UNDER ITS PATENT RIGHTS, NOR THE RIGHTS OF OTHERS. THESE SPECIFICATIONS DO NOT EXPAND THE TERMS OF FAIRCHILD'S WORLDWIDE TERMS AND CONDITIONS, SPECIFICALLY THE WARRANTY THEREIN, WHICH COVERS THESE PRODUCTS.

LIFE SUPPORT POLICY

FAIRCHILD'S PRODUCTS ARE NOT AUTHORIZED FOR USE AS CRITICAL COMPONENTS IN LIFE SUPPORT DEVICES OR SYSTEMS WITHOUT THE EXPRESS WRITTEN APPROVAL OF FAIRCHILD SEMICONDUCTOR CORPORATION.

As used herein:

1. Life support devices or systems are devices or systems which, (a) are intended for surgical implant into the body or (b) support or sustain life, and (c) whose failure to perform when properly used in accordance with instructions for use provided in the labeling, can be reasonably expected to result in a significant injury of the user.
2. A critical component in any component of a life support, device, or system whose failure to perform can be reasonably expected to cause the failure of the life support device or system, or to affect its safety or effectiveness.

ANTI-COUNTERFEITING POLICY

Fairchild Semiconductor Corporation's Anti-Counterfeiting Policy. Fairchild's Anti-Counterfeiting Policy is also stated on our external website, www.fairchildsemi.com, under Sales Support.

Counterfeiting of semiconductor parts is a growing problem in the industry. All manufacturers of semiconductor products are experiencing counterfeiting of their parts. Customers who inadvertently purchase counterfeit parts experience many problems such as loss of brand reputation, substandard performance, failed applications, and increased cost of production and manufacturing delays. Fairchild is taking strong measures to protect ourselves and our customers from the proliferation of counterfeit parts. Fairchild strongly encourages customers to purchase Fairchild parts either directly from Fairchild or from Authorized Fairchild Distributors who are listed by country on our web page cited above. Products customers buy either from Fairchild directly or from Authorized Fairchild Distributors are genuine parts, have full traceability, meet Fairchild's quality standards for handling and storage and provide access to Fairchild's full range of up-to-date technical and product information. Fairchild and our Authorized Distributors will stand behind all warranties and will appropriately address any warranty issues that may arise. Fairchild will not provide any warranty coverage or other assistance for parts bought from Unauthorized Sources. Fairchild is committed to combat this global problem and encourage our customers to do their part in stopping this practice by buying direct or from authorized distributors.

PRODUCT STATUS DEFINITIONS

Definition of Terms

Datasheet Identification	Product Status	Definition
Advance Information	Formative / In Design	Datasheet contains the design specifications for product development. Specifications may change in any manner without notice.
Preliminary	First Production	Datasheet contains preliminary data; supplementary data will be published at a later date. Fairchild Semiconductor reserves the right to make changes at any time without notice to improve design.
No Identification Needed	Full Production	Datasheet contains final specifications. Fairchild Semiconductor reserves the right to make changes at any time without notice to improve the design.
Obsolete	Not In Production	Datasheet contains specifications on a product that is discontinued by Fairchild Semiconductor. The datasheet is for reference information only.

Rev. I37